

Specifications

Parameter	Unit	Minimum	Typical	Maximum
Center Frequency	MHz	159.9	160	160.1
Insertion Loss	dB	-	20.8	25
3 dB Bandwidth	MHz	14.3	14.38	-
35 dB Bandwidth	MHz	-	15.5	15.6
40 dB Bandwidth	MHz	-	15.6	15.7
50 dB Bandwidth	MHz	-	15.7	-
Passband Variation	dB	-	1.2	1.4
Absolute Delay	usec	-	2.467	-
Ultimate Rejection	dB	48	55	-
Material Temperature coefficient	KHz/°C	-15.04		
Ambient Temperature	°C	25		
Package Size	DIP3512 (35.0x12.8x4.7mm3)			

Notes:

1. All specifications are based on the test circuit shown
2. In production, devices will be tested at room temperature to a guardbanded specification to ensure electrical compliance over temperature
3. Electrical margin has been built into the design to account for the variations due to temperature drift and manufacturing tolerances
4. This is the optimum impedance in order to achieve the performance show

Matching Configuration

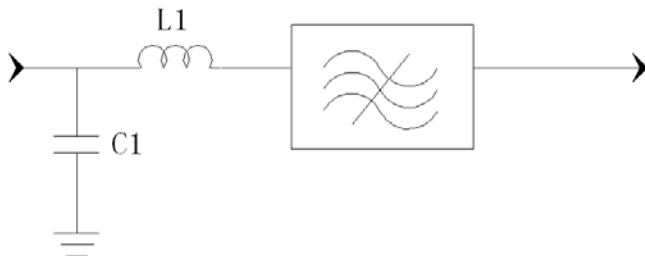

L1=18nH c1=22pF
Source/Load Impedance=50 ohm

Notes - Component values may change depending on board layout.



SIPAT Co., Ltd.
(CETC No. 26 Research Institute)
Nanping Huayuan Road No. 14
Chongqing, China, 400060

Part Number	LBN16029		
Rev. Date	2005-11-7		
Rev.	1.0	Page 1/3	

Package Dimension

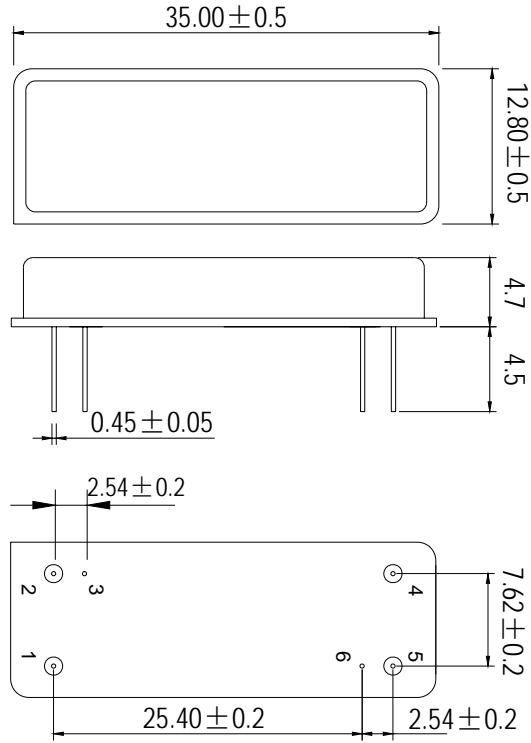

Input:1
Output:5



SIPAT Co., Ltd.
(CETC No. 26 Research Institute)
Nanping Huayuan Road No. 14
Chongqing, China, 400060

Part Number	LBN16029	
Rev. Date	2005-11-7	
Rev.	1.0	Page 2/3

Typical Performance

Frequency Response

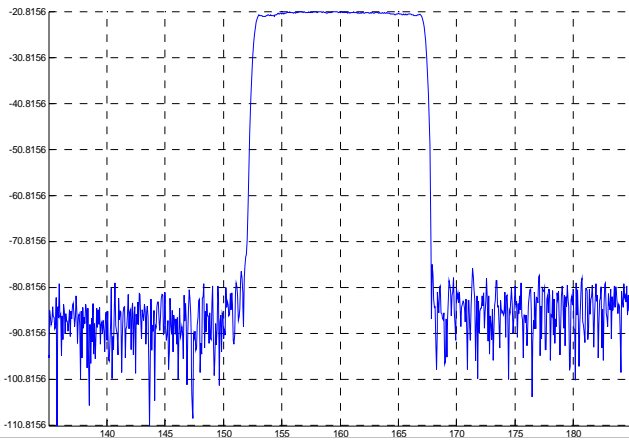

Passband Response

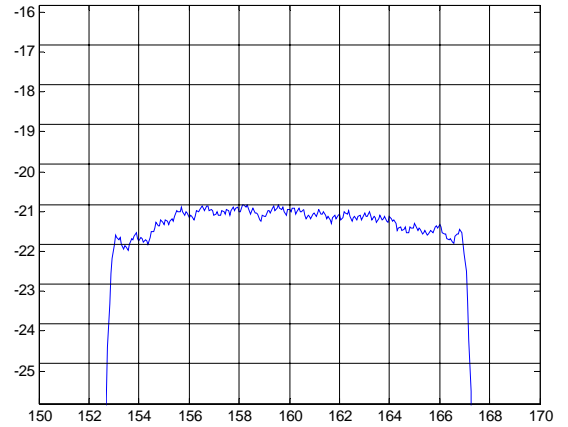

Group Delay Variation($f_0 \pm 7\text{MHz}$)

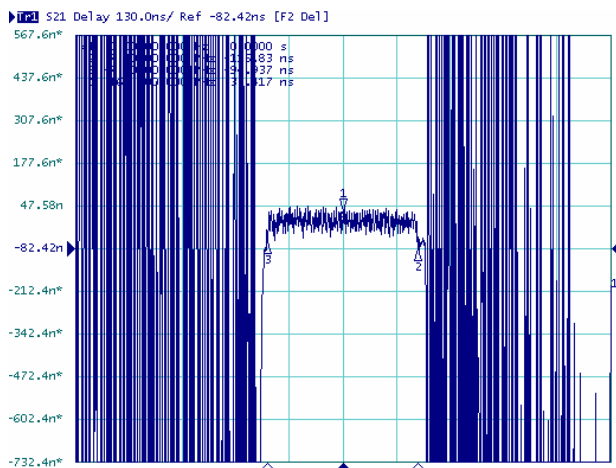

Phase Linearity($f_0 \pm 7\text{MHz}$)

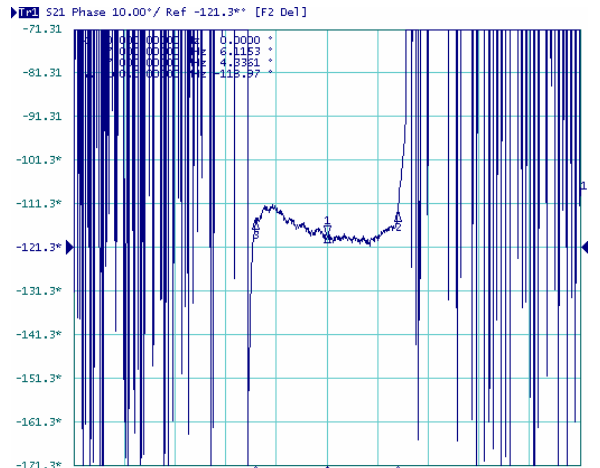

Smith Chart S11

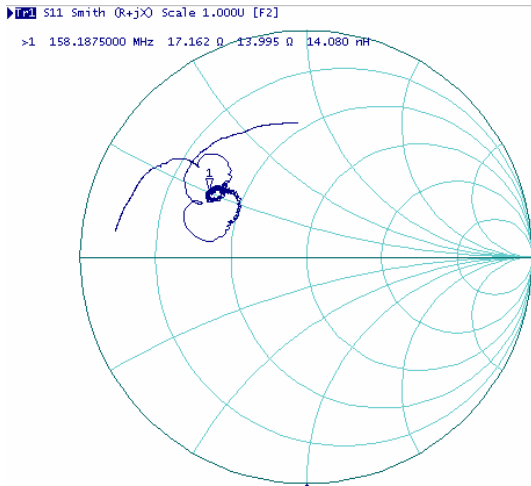

Smith Chart S22

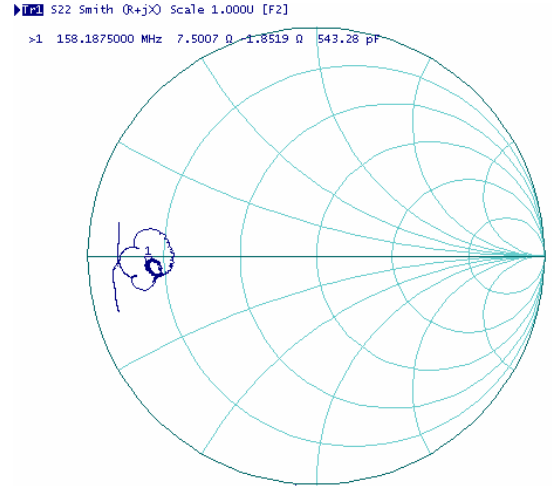

Part Number	LBN16029	
Rev. Date	2005-11-7	
Rev.	1.0	Page 3/3